

Chailey Toilet Seat

INSTRUCTIONS FOR USE

Codes 8301-8309



CONTENTS	PAGE
1.0 INTRODUCTION	1
2.0 ILLUSTRATION OF YOUR CHAILEY TOILET SEAT	2
3.0 FOR YOUR SAFETY	2
4.0 UNPACKING YOUR SEAT	3
5.0 PREPARATIONS FOR USE	4
6.0 HOW TO USE YOUR CHAILEY TOILET SEAT	7
7.0 CARE & MAINTENANCE	8
8.0 GUARANTEE & SERVICE	9
9.0 CONTINUOUS IMPROVEMENT	9
10.0 WARRANTY & AFTERSALE	10

1.0 INTRODUCTION

Thank you for choosing the Smirthwaite Chailey Toilet & Showering Seat.

The Chailey Toilet Seat is designed to provide support and stability for children who are unable to sit independently on a standard toilet. The seat's contoured design gives your child greater postural support and comfort. Its shape ensures the pelvis is held securely in a position that facilitates bowel movement so that effective toileting is achieved.

	<p>IMPORTANT!</p>
	<p>These instructions should be read by all therapists and carers using the equipment and should be retained for future reference. The product should always be used under adult supervision.</p> <p>Any incorrect use of the product and failure to follow the instructions may put the user at risk or impede the function. If you have any queries using this product or wish for further copies, please do not hesitate to contact Customer Service department on T: +44 (0) 1626 835552.</p>

2.0 ILLUSTRATION OF YOUR CHAILEY TOILET SEAT

- A. Seat
- B. Mobile base
- C. Adjustable footrest (standard with mobile base)
- D. Potty (optional accessory)
- E. Full strap harness

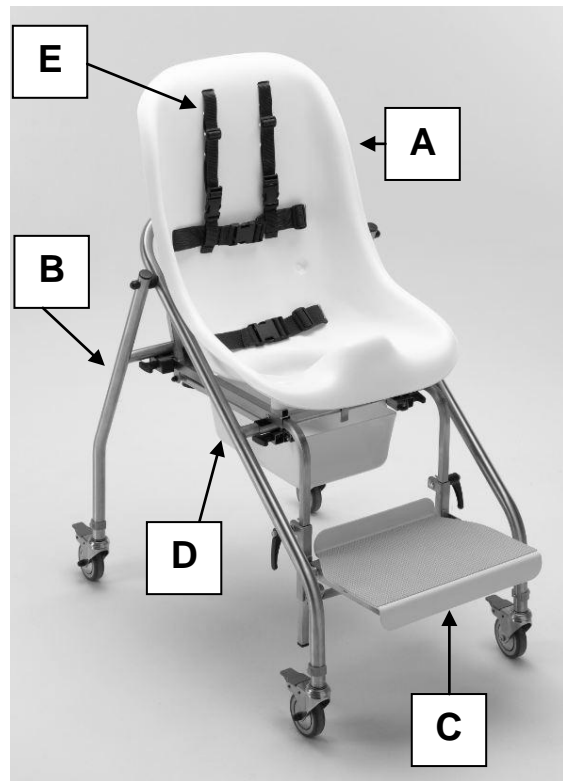

3.0 FOR YOUR SAFETY

	STOP!
	Please read these instructions CAREFULLY and THOROUGHLY.

- The user should **NOT** be left unattended whilst in the seat. Always ensure a responsible therapist or carer is in attendance.
- If you believe the seat or any fitted accessory to be faulty at any time, **DO NOT USE** – contact Smirthwaite by telephone on +44 (0) 1626 835552.
- Suitability of this product to the child's needs, correct adjustment and maintenance are the responsibility of the professional care team.
- Check that the seat is securely attached to the toilet or mobile base before transferring the child into the seat – check castors are **LOCKED** before transfer into a chair fitted with a mobile base.
- The seat is **ONLY** to be used indoors on a flat level surface.
- The mobile base is intended to assist maneuverability only; it is not designed for mobility purposes (room to room).

- **DO NOT EXCEED USER MAXIMUM WEIGHT LIMITS** as shown below:

Size	Maximum User Weight
1	45kg
2	60kg
3	75kg

- Always fasten the straps provided with the seat.
- Regular maintenance checks and cleaning are essential for the safe use of this equipment (see Section 6.0 Care and Maintenance).
- Always keep this product away from naked flames, cigarettes and sources of heat including open fireplaces, radiators and heaters.
- **DO NOT** fit parts or accessories of other manufacturers to this product unless authorised to do so in writing by G&S Smirthwaite Ltd. Failure to follow these instructions will not only invalidate the guarantee but could make the seat dangerous to use.
- G&S Smirthwaite Ltd will not accept liability for any injury or damage incurred through such malpractices. Any repairs required must be carried out by G&S Smirthwaite Ltd authorised personnel.

4.0 UNPACKING YOUR SEAT

- When delivered, the seat will be supplied fully assembled except for the attachment of any special accessories ordered.
- If your order has been supplied as a custom kit, please ensure you follow both the instructions documented in this IFU **and** any additional instructions supplied.
- Please take note of any instructions on the packaging/box when unpacking.
- Once the seat has been carefully unpacked, please check all parts.

If you believe this product to be faulty - **DO NOT USE** - Contact G&S Smirthwaite Ltd on T: +44 (0) 1626 835552.

5.0 PREPARATIONS FOR USE

	STOP!
	If in any doubt, ALWAYS seek ADVICE.

PLEASE NOTE: ALWAYS TURN LEVER HANDWHEELS AND SCREWS CLOCKWISE TO TIGHTEN OR ANTI-CLOCKWISE TO LOOSEN. THE CHAIR MUST BE FULLY ADJUSTED BY A THERAPIST OR TRAINED REPRESENTATIVE BEFORE USE.

5.1 ERECTING AND FOLDING THE MOBILE BASE FRAME

- To collapse/fold an erected mobile frame, pull the spring plungers (A) located on the front of the mobile base until they can be angled and locked into a disengaged position (1a).
- Hold the frame by the back legs, allowing the front legs to swing open.

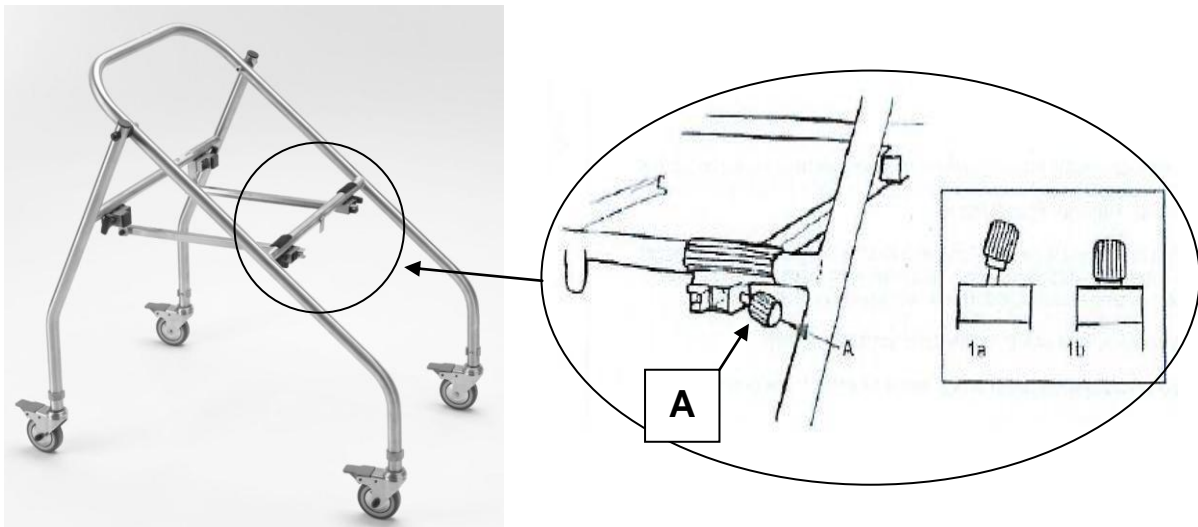

- Open the frame to its full extent and release the spring plungers, ensure that they fully engage into the locating holes (1b).
- To fold the frame, firstly lock the front castors. Release the spring plungers (A) and lift the rear of the frame to fold the mobile base flat as shown below.



5.2 FITTING TO A TOILET (USING TOILET MOUNTING BRACKET)



STOP!

Before undertaking installation, ensure the toilet is securely fixed to the ground/floor – if in doubt, consult a qualified plumber.

- The Chailey Toilet Seat can be mounted directly onto most toilets by using the mounting bracket provided.
- Firstly remove the toilet seat by undoing nuts (B) and lifting seat off (being careful to retain any washers).
- Place the mounting bracket on to the seat as shown below, and refit the original toilet seat. Ensure it is securely fitted using nuts (B) and any washers.

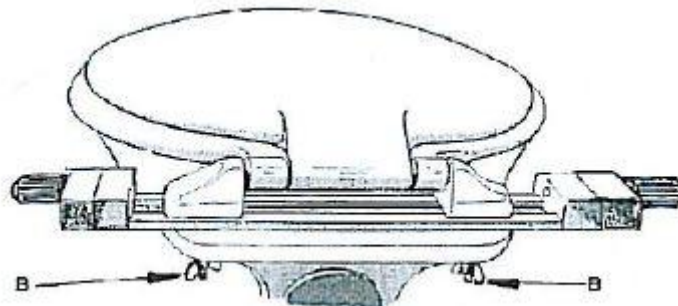

5.3 FITTING THE CHAILEY SEAT TO THE TOILET OR MOBILE FRAME

- Pull the black knobs (C) on the spring plungers until they can be angled and locked into a disengaged position (1a).
- Offer up the Chailey seat and insert the tubes on the rear of the seat into the fixing points on the mobile frame or toilet mounting bracket.
- Release the spring plungers, ensuring that they fully engage into the locating holes (1b).

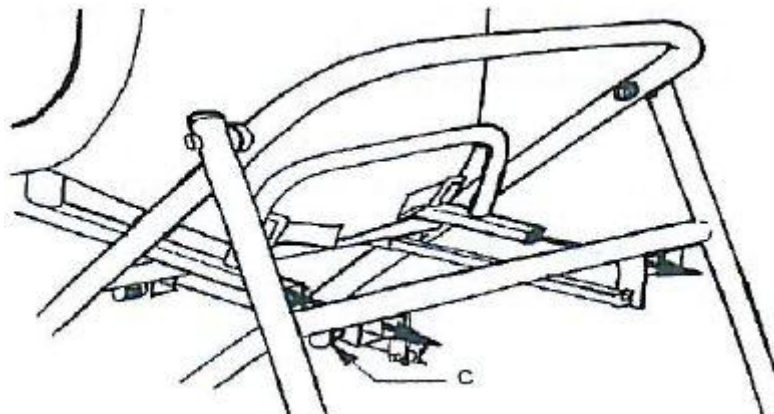

5.4 FITTING THE ADJUSTABLE FOOTREST

- The adjustable footrest is fitted to the frame of the Chailey seat by inserting the footrest tubes into the ends of the frame tube until the button clips (D) locate securely.
- The footrest height is adjusted using the clamping levers (E) on either side of the foot plate.
- The footrest can be flipped up (vertically) to aid transfer into the Chailey seat.

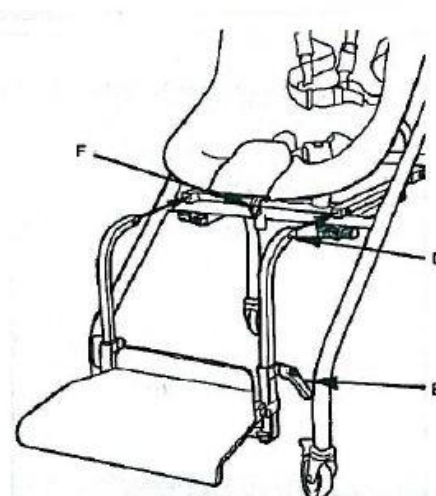

5.5 USING A POTTY

- The potty accessory slides underneath the moulded seat from the back, using the stainless steel channels (see opposite).
- Slide the potty as far forward as it will go, to ensure that it lines up with the aperture in the moulded seat.

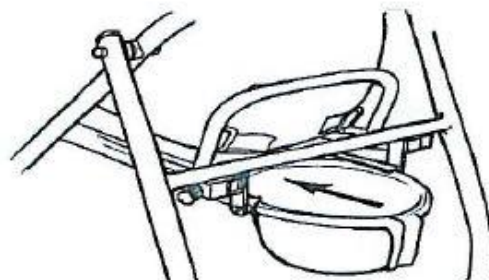

5.6 OTHER ACCESSORIES

- A padded seat liner is available for the Chailey Toilet seat; it is held in place by a drawstring (F) around the outside edge of the moulded seat. The chest and lap straps or harness are threaded through the slots in the seat liner.
- A splash guard is available which extends the moulded pommel, and attaches with Velcro.

6.0 HOW TO USE YOUR CHAILEY TOILET SEAT

	IMPORTANT!
	Adjustment of the footrest, straps and harness should be undertaken BEFORE transferring a child into the Chailey Toilet Seat.

- Before attempting any transfer **lock** all four castors (if used on a mobile frame).
- Check that the seat is secure on the frame or toilet, and the footrest is tightened in place.
- The footrest can be flipped up (vertical) to aid transfer.

7.0 CARE AND MAINTENANCE

	IMPORTANT!
	Cleaning is recommended on a regular basis.

- Clean the straps and any padding with a damp cloth and mild detergent.
- Do not soak or immerse the liner (if fitted) in water.
- Store the seat in a cool dry place and out of direct sunlight.
- DO NOT use bleach, solvents, abrasives, synthetic detergents, wax polishes, antibacterial sprays or wipes.
- Ensure that the toilet seat is clean and dry before any storage.
- For further information please refer to MHRA or your NHS cleaning guidelines.

7.1 DAILY CHECKS

- Check all parts for signs of wear and tear or damage.
- Check all straps for fraying, and that buckles are not missing/damaged.
- Check the seat for stability, and make sure it is firmly fixed to either the toilet seat frame or mobile frame.
- If using a mobile frame, check castors rotate freely and lock securely (when brakes are applied).
- If using a footrest, check it is securely fixed to the mobile frame and has no loose or missing parts.
- Check that the leg screws are present and are tightened correctly.

	STOP!
	The user should not be seated while the checks are carried out.

7.2 SERVICE INTERVAL

The Chailey Toilet seat should be serviced every 3 years. Servicing must only be undertaken by a Smirthwaite service engineer, or by a Smirthwaite trained representative.

8.0 GUARANTEE & SERVICE

The seat is issued with a full parts and labour guarantee for 2 years from the date of delivery. This guarantee does not apply to accidental damage caused through inappropriate use of the seat. This guarantee is issued at the discretion of G&S Smirthwaite Ltd on RTB (Return to Base) basis. If you have any questions or doubts relating to the safety or use of the chair please contact us for advice or assistance on:

T: +44 (0) 1626 835552

E: info@smirthwaite.co.uk

9.0 CONTINUOUS IMPROVEMENT

G&S Smirthwaite Ltd are committed to continuous improvement to their product range. Should you have any suggestions or comments please send them to our product design department at: info@smirthwaite.co.uk

G&S Smirthwaite Ltd reserve the right to change the specification or material without prior notice.

For catalogues, help and further information on our products please contact us at:

G&S Smirthwaite Ltd
17 Wentworth Road
Heathfield
Devon TQ12 6TL

T: +44 (0) 1626 835552

F: +44 (0) 1626 835428

E: info@smirthwaite.co.uk

W: www.smirthwaite.co.uk



G&S Smirthwaite, 17 Wentworth Road, Heathfield, Newton Abbot, Devon.TQ12 6TL
T: +44 (0) 1626 835552 F: +44 (0) 1626 835428 E: info@smirthwaite.co.uk
W: www.smirthwaite.co.uk