

	min	small/ paed	Junior	Medium	Large	Tall	max
a	375	375	450	550	560	560	820
b	100	100	180	240	240	240	360
c	75	75	90	125	125	125	185
d	80	80	150	200	200	200	300
e	75	75	90	100	100	100	150
f	410	410	490	580	800	1000	1200

Filling: Visco-Elastic Crumb (Memory Foam)  
Removable Cover: Yes

The **W LEG TROUGH** comes complete with **WRAP**

PRODUCT CODE      W/T - W LEG TROUGH and WRAP Tall size  
 W/L - W LEG TROUGH and WRAP Large size  
 W/M - W LEG TROUGH and WRAP Medium size  
 W/J - W LEG TROUGH and WRAP Junior size  
 W/S - W LEG TROUGH and WRAP Small size  
 W/PA - W LEG TROUGH and WRAP Paediatric size

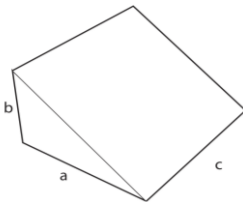

	min	small	max
a	75	145	2000
b	75	145	1000
c	100	210	2000

Filling: 9lb Chip  
Removable Cover: No

**WEDGE**

PRODUCT CODE      WE/S - WEDGE small size

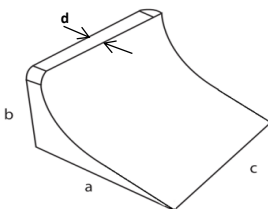

	min	paed	small	large	max
a	100	100	125	150	250
b	100	100	125	150	250
c	120	120	125	250	700
d	30	30	30	30	50

Filling: 9lb Chip  
Curved Face: Visco-Elastic Foam (Memory Foam)  
Removable Cover: Yes

**PADDED CURVED WEDGE**

PRODUCT CODE      WEC/L - PADDED CURVED WEDGE Large size  
 WEC/S - PADDED CURVED WEDGE Small size  
 WEC/PA - PADDED CURVED WEDGE Paediatric size

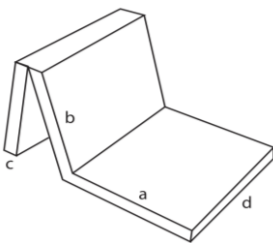

	min	paed	small	large	max
a	85	85	120	200	400
b	100	100	150	200	400
c	25	25	25	25	100
d	140	140	180	210	600

Filling: Visco-Elastic Foam (Memory Foam)  
Removable Cover: No

**TRIFOLD inc BRACKET**

PRODUCT CODE      BR/P3/L - TRIFOLD LARGE  
 BR/P3/S - TRIFOLD SMALL  
 BR/P3/PA - TRIFOLD PAEDIATRIC

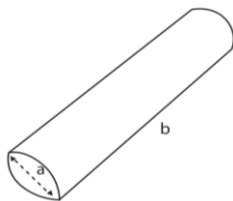

	min	paed	std	max
a	50	70	150	500
b	250	460	900	2000

Filling: Visco-Elastic Crumb (Memory Foam)  
Removable Cover: Yes

**LONG ROLL**

PRODUCT CODE      RL - LONG ROLL Standard size  
 RL/PA - LONG ROLL Paediatric size



snooooooze product sizes, all in mm's  
 All items covered in White Dartex\*, inner covers produced from  
 FireCheck  
 \*t/s' notes To Specification - 'n/a' notes Not Available

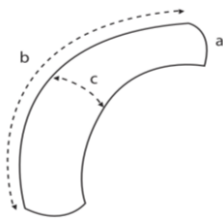

	min	paed	std	max
a	100	100	180	260
b	450	450	850	1200
	120	120	200	300

Filling: Visco-Elastic Crumb (Memory Foam)  
Removable Cover: Yes

**BANANA**

PRODUCT CODE BC - BANANA CUSHION Standard size  
BC/PA - BANANA CUSHION Paediatric size

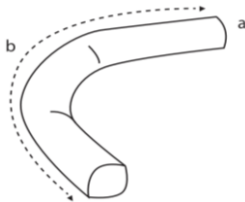

	min	paed	std	tall	max
a	50	100	150	150	500
b	250	1300	2000	2760	3000

Filling Stand/Tall: Comfy Foam  
Filling Paediatric: Visco-Elastic Crumb (Memory Foam)  
Removable Cover: Yes

**BODY ROLL**

PRODUCT CODE RB/T - BODY ROLL Tall  
RB - BODY ROLL Standard size  
RB/PA - BODY ROLL Paediatric size

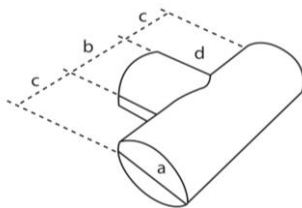

	min	paed	std	max
a	100	150	250	400
b	100	150	250	400
c	100	225	250	400
d	100	150	250	400

Filling: Visco-Elastic Crumb (Memory Foam)  
Removable Cover: Yes

**T ROLL**

PRODUCT CODE ROLL/T - T ROLL Standard size  
ROLL/T/PA - TROLL Paediatric size

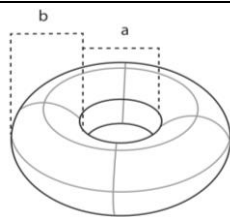

	min	std	max
a	n/a	150	n/a
b	n/a	150	n/a

Filling: Visco-Elastic Crumb (Memory Foam)  
Removable Cover: No

**NECK RING**

PRODUCT CODE NR - NECK RING Standard size

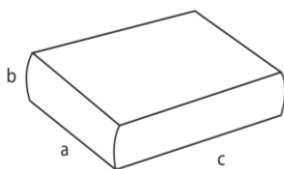

	min	std	max
a	100	400	1000
b	100	80	1000
c	100	700	1000

Filling: Visco-Elastic Crumb (Memory Foam)  
Removable Cover: Yes

**BOX PILLOW**

PRODUCT CODE BP - BOX PILLOW Standard size



	min	paed	std	max
a	100	410	800	1000
b	100	410	800	1000

Filling: Visco-Elastic Crumb (Memory Foam)  
Removable Cover: Yes

**LARGE PILLOW**

PRODUCT CODE LP - LARGE PILLOW Standard size  
LP/PA - LARGE PILLOW Paediatric size



snoooooze product sizes, all in mm's  
 All items covered in White Dartex\*, inner covers produced from FireCheck  
 \*t/s notes To Specification - 'n/a' notes Not Available  
 \* Special option covers available

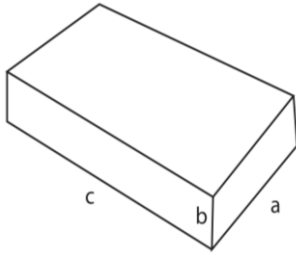

	UK std Single	UK std Double	UK std King
a	900	1350	1500
b	depth up to 150mm (see Note 1)		
c	1900	1900	2000

Material: Hook and Loop receptive

**Note 1 Mattress Depth:**

There is 100mm underside grip added to the standard 150mm depth.  
For cot and non standard size mattresses please supply a, b and c as the actual mattress size.

**MATTRESS COVER**

PRODUCT CODE MC/C - MATTRESS COVER Cot  
MC/S - MATTRESS COVER Single  
MC/D - MATTRESS COVER Double  
MC/K - MATTRESS COVER King

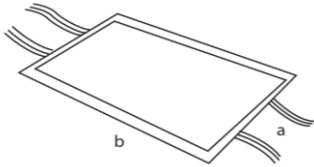

	min	std	max
a	300	1000	1300
b	300	1730	2500

Material: Hook and Loop receptive

**THERAPY MAT**

PRODUCT CODE TM - THERAPY MAT

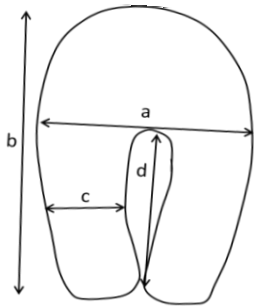

	min	paed	medium	max
a	n/a	500	760	t/s
b	n/a	640	1000	t/s
c	n/a	180	210	t/s
d	n/a	340	600	t/s

Filling: Visco-Elastic Crumb (Memory Foam)  
Removable Cover: Yes

**HORSESHOE**

PRODUCT CODE H/M - HORSESHOE Medium size  
H/PA - HORSESHOE Paediatric size

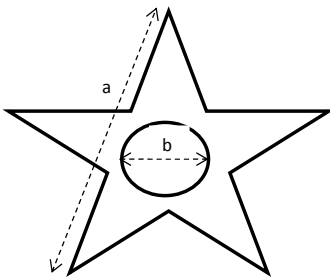

	min	paed	std	max
a	n/a	560	690	t/s
b	n/a	80	100	t/s

Filling: Visco-Elastic Crumb (Memory Foam)  
Removable Cover: No

**STAR**

PRODUCT CODE ST - STAR Standard size  
ST/PA - STAR Paediatric size

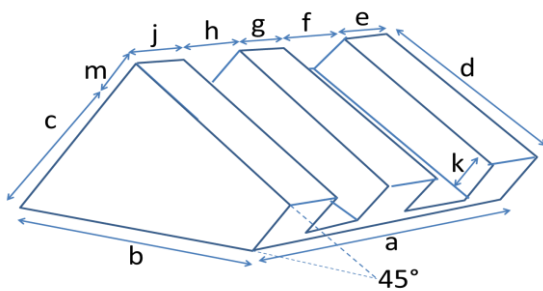

	min	paed	max
a	t/s	305	t/s
b	t/s	210	t/s
c	t/s	210	t/s
d	t/s	150	t/s
e	t/s	50	t/s
f	t/s	65	t/s
g	t/s	75	t/s
h	t/s	65	t/s
j	t/s	50	t/s
k	t/s	60	t/s
m	t/s	50	t/s

Filling: 9lb Chip  
Removable Cover: Yes

**FOOT SUPPORT**

PRODUCT CODE FS - FOOT SUPPORT Adult size  
FS/PA - FOOT SUPPORT Paediatric size  
FS/AS - FOOT SUPPORT Adult Assessment

snooooooze product sizes, all in mm's  
All items covered in White Dartex\*, inner covers produced from FireCheck  
\*t/s' notes To Specification - n/a' notes Not Available

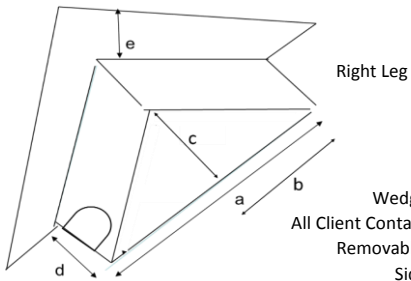

	min	paed	max
a	t/s	t/s	t/s
b	t/s	t/s	t/s
c	t/s	t/s	t/s
d	t/s	t/s	t/s
e	t/s	t/s	t/s

Right Leg  
 Wedge Block: 9lb Chip  
 All Client Contact Faces: Padded  
 Removable Cover: Yes  
 Side Board ABS

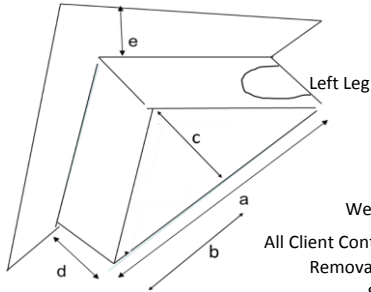

	min	paed	max
a	t/s	t/s	t/s
b	t/s	t/s	t/s
c	t/s	t/s	t/s
d	t/s	t/s	t/s
e	t/s	t/s	t/s

Left Leg  
 Wedge Block: 9lb Chip  
 All Client Contact Faces: Padded  
 Removable Cover: Yes  
 Side Board ABS

**TWIN LEG WEDGE**

PRODUCT CODE WE2 - TWIN LEG WEDGE  
 (Supplied as a pair though can be diferent sizes)



**This configuration is for supporting from the inside of the leg.**

In this configuration the bracket is cut away to profile around the groin

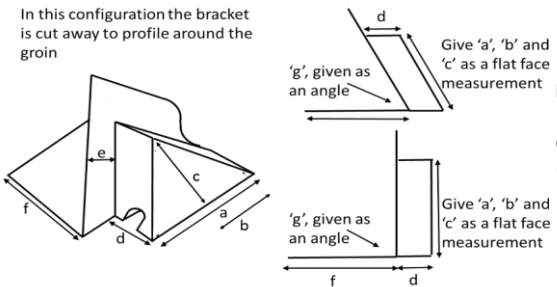

	min	paed	max
a	t/s	t/s	t/s
b	t/s	t/s	t/s
c	t/s	t/s	t/s
d	t/s	t/s	t/s
e	t/s	t/s	t/s
f	t/s	t/s	t/s
g	as °	as °	as °

This supportive bracket can be angled from upright to lean away.

Wedge Block: 9lb Chip  
 All Client Contact Faces: Padded  
 Removable Cover: Yes  
 Side Board ABS

Note: The wedge can be either fixed or removable to facilitate the placement.  
 Heel cutouts are standard as 75mm x 75mm. There is padding on the board for the non wedged leg

**INSIDE LEG SUPPORT and WEDGE**

PRODUCT CODE WE1/INL - SINGLE LEG WEDGE  
 Illustration for left leg, please note if right as WE1/INR

**This configuration is for supporting from the outside of the leg.**

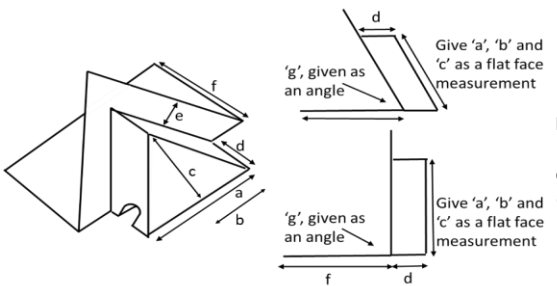

	min	paed	max
a	t/s	t/s	t/s
b	t/s	t/s	t/s
c	t/s	t/s	t/s
d	t/s	t/s	t/s
e	t/s	t/s	t/s
f	t/s	t/s	t/s
g	as °	as °	as °

This supportive bracket can be angled from upright to lean away.

Wedge Block: 9lb Chip  
 All Client Contact Faces: Padded  
 Removable Cover: Yes  
 Side Board ABS

Note: The wedge can be either fixed or removable to facilitate the placement. Heel cutouts are standard as 75mm x 75mm

**OUTSIDE LEG SUPPORT and WEDGE**

PRODUCT CODE WE1/OUTR - SINGLE LEG WEDGE  
 Illustration for right leg, please note if left as WE1/OUTL

snoooooze product sizes, all in mm's  
 All items covered in White Dartex\*, inner covers produced from FireCheck  
 't/s' notes To Specification - 'n/a' notes Not Available  
 \* Special option covers available

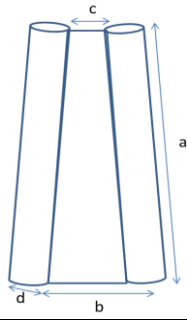

	min	std	max
a	250	900	2000
b	100	460	1500
c	100	360	1500
d	50	150	500

Filling: Comfy  
Removable Cover: Yes

**TWIN SIDE ROLLS and FLAP**  
PRODUCT CODE 2RL/AB - TWIN SIDE ROLLS and FLAP Standard size

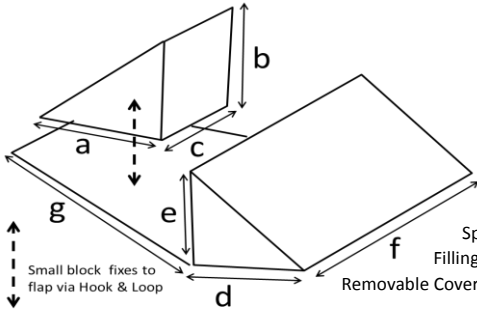

	min	std	max
a	n/a	150	n/a
b	n/a	150	n/a
c	n/a	200	n/a
d	n/a	150	n/a
e	n/a	150	n/a
f	n/a	410	n/a
g	n/a	420	n/a

Space between blocks  
Filling: 9lb Chip  
Removable Cover: Yes (manufactured in coloured Dartex)

**SIDNEY**  
PRODUCT CODE SID SIDNEY Side Positioner



snooooooze product sizes, all in mm's  
All items covered in White Dartex\*, inner covers produced from FireCheck  
\*t/s' notes To Specification - 'n/a' notes Not Available  
\* Special option covers available

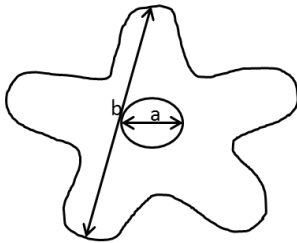

	Little dots
a	50
b	280

Filling: Fibre  
Removable Cover: No

**DAISY**  
PRODUCT CODE LD/D - Daisy

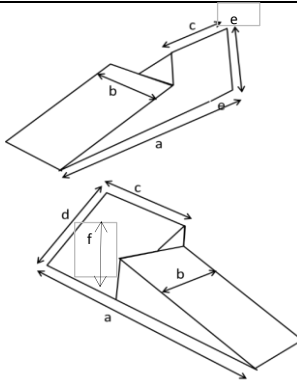

	min	little dots	max
a	t/s	280	t/s
b	t/s	80	t/s
c	t/s	100	t/s
d	t/s	113	t/s
e	t/s	80	t/s
f	t/s	50	t/s

Filling: 9lb Chip  
Removable Cover: No

**WEDGE and RAMP**  
PRODUCT CODE LD/WR/PR - Wedge and Ramp

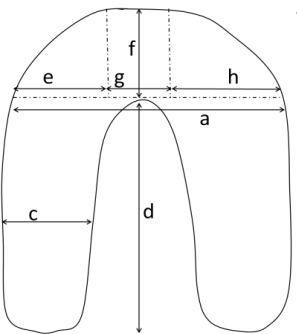

	min	Little dots	max
a	n/a	400	t/s
b	n/a	450	t/s
c	n/a	120	t/s
d	n/a	300	t/s
e	n/a	150	t/s
f	n/a	150	t/s
g	n/a	100	t/s
h	n/a	150	t/s

Filling: Visco-Elastic Crumb (Memory Foam)  
Removable Cover: Yes

**SEGMENTED HORSESHOE**  
PRODUCT CODE LD/H/SEG - HORSESHOE Segmented

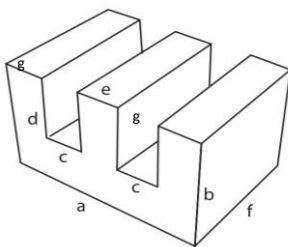

	min	Little dots	max
a	n/a	350	n/a
b	n/a	100	n/a
c	n/a	65	n/a
d	n/a	75	n/a
e	n/a	80	n/a
f	n/a	190	n/a
g	n/a	70	n/a

Filling: Visco-Elastic Crumb (Memory Foam)  
Removable Cover: Yes

**BOX W**  
PRODUCT CODE LD/BOXW - BOX W

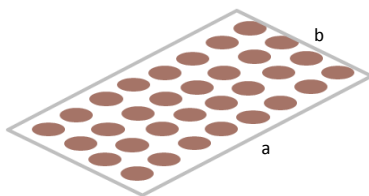

	min	Little dots	max
a	n/a	1000	n/a
b	n/a	700	n/a

Material: Twinsided fleece, Pink/Blue

**FLEECE**  
PRODUCT CODE LD/FL - FLEECE Two-sided Pink and Blue



Little dots product sizes, all in mm's  
All items covered in White Dartex\*, inner covers produced from FireCheck, Fleece in Pink/Blue.  
\*t/s' notes To Specification - 'n/a' notes Not Available  
\* Special option covers available

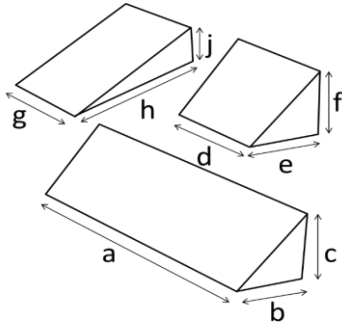

	min	Little dots	max
a	n/a	300	n/a
b	n/a	100	n/a
c	n/a	100	n/a
d	n/a	100	n/a
e	n/a	100	n/a
f	n/a	30	n/a
g	n/a	50	n/a
h	n/a	100	n/a
j	n/a	50	n/a

Filling: 9lb Chip  
Removable Cover: Yes

**WEDGE SET**

PRODUCT CODE LD/WE/L/PR - LARGE WEDGES Pair  
LD/WE/M/PR - MEDIUM WEDGES Pair  
LD/WE/S/PR - SMALL WEDGES Pair

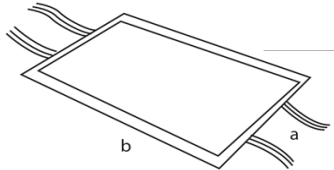

	min	Little dots	max
	300	500	1300
	300	700	2500

Material: Hook and Loop receptive

**THERAPY MAT**

PRODUCT CODE TM/LD - THERAPY MAT LITTLE DOTS



Little dots product sizes, all in mm's  
All items covered in White Dartex\*, inner covers produced from FireCheck, Fleece in Pink/Blue.  
't/s' notes To Specification - 'n/a' notes Not Available  
\* Special option covers available